

Description

The LCE60P50K uses advanced trench technology to provide excellent $R_{DS(ON)}$, low gate charge and operation with gate voltages as low as 4.5V. This device is suitable for use as a Battery protection or in other Switching application.

General Features

$V_{DS} = -60V$ $I_D = -50A$

$R_{DS(ON)} < -18m\Omega$ @ $V_{GS} = -10V$

Application

Battery protection

Load switch

Uninterruptible power supply

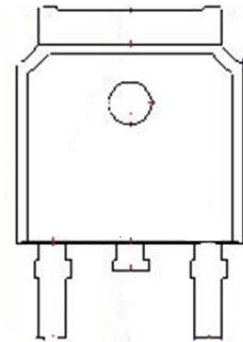
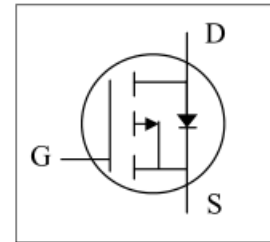

Package Marking and Ordering Information

Product ID	Pack	Marking	Qty(PCS)
LCE60P50K	TO-252	AP50P06D XXX YYYY	2500

Absolute Maximum Ratings ($T_C = 25^\circ C$ unless otherwise noted)

Parameter	Symbol	Limit	Unit
Drain-Source Voltage	V_{DS}	-60	V
Gate-Source Voltage	V_{GS}	± 20	V
Drain Current-Continuous	I_D	-50	A
Drain Current-Continuous($T_C = 100^\circ C$)	$I_D(100^\circ C)$	-42.3	A
Pulsed Drain Current	I_{DM}	-260	A
Maximum Power Dissipation	P_D	130	W
Derating factor		0.87	W/ $^\circ C$
Single pulse avalanche energy ^(Note 5)	E_{AS}	722	mJ
Operating Junction and Storage Temperature Range	T_J, T_{STG}	-55 To 175	$^\circ C$
Thermal Resistance, Junction-to-Case ^(Note 2)	$R_{\theta JC}$	1.15	$^\circ C/W$

Electrical Characteristics (T_C=25°C unless otherwise noted)

Parameter	Symbol	Condition	Min	Typ	Max	Unit
Drain-Source Breakdown Voltage	BV _{DSS}	V _{GS} =0V, I _D =-250μA	-60	-	-	V
Zero Gate Voltage Drain Current	I _{DSS}	V _{DS} =-60V, V _{GS} =0V	-	-	-1	μA
Gate-Body Leakage Current	I _{GSS}	V _{GS} =±20V, V _{DS} =0V	-	-	±100	nA
Gate Threshold Voltage	V _{GS(th)}	V _{DS} =V _{GS} , I _D =-250μA	-2.0	-2.6	-3.5	V
Drain-Source On-State Resistance	R _{DS(ON)}	V _{GS} =-10V, I _D =-20A	-	13	18	mΩ
Forward Transconductance	g _{FS}	V _{DS} =-5V, I _D =-20A	-	25	-	S
Input Capacitance	C _{ISS}	V _{DS} =-25V, V _{GS} =0V, F=1.0MHz	-	5814	-	PF
Output Capacitance	C _{OSS}		-	483	-	PF
Reverse Transfer Capacitance	C _{RSS}		-	234	-	PF
Turn-on Delay Time	t _{d(on)}	V _{DD} =-30V, R _L =1.5Ω, V _{GS} =-10V, R _G =3Ω	-	18	-	nS
Turn-on Rise Time	t _r		-	20	-	nS
Turn-Off Delay Time	t _{d(off)}		-	55	-	nS
Turn-Off Fall Time	t _f		-	35	-	nS
Total Gate Charge	Q _g	V _{DS} =-30, I _D =-20A, V _{GS} =-10V	-	75		nC
Gate-Source Charge	Q _{gs}		-	16		nC
Gate-Drain Charge	Q _{gd}		-	19		nC
Diode Forward Voltage ^(Note 3)	V _{SD}	V _{GS} =0V, I _S =-20A	-		-1.2	V
Diode Forward Current ^(Note 2)	I _S		-	-	-65	A
Reverse Recovery Time	t _{rr}	T _J = 25°C, I _F = -20A di/dt = -100A/μs ^(Note3)	-	49		nS
Reverse Recovery Charge	Q _{rr}		-	71		nC
Forward Turn-On Time	t _{on}	Intrinsic turn-on time is negligible (turn-on is dominated by LS+LD)				

Notes:

1. Repetitive Rating: Pulse width limited by maximum junction temperature.
2. Surface Mounted on FR4 Board, t ≤ 10 sec.
3. Pulse Test: Pulse Width ≤ 300μs, Duty Cycle ≤ 2%.
4. Guaranteed by design, not subject to production
5. E_{AS} condition: T_J=25°C, V_{DD}=-30V, V_G=-10V, L=0.5mH, R_G=25Ω Typical Electrical and Thermal Characteristics (Curves)

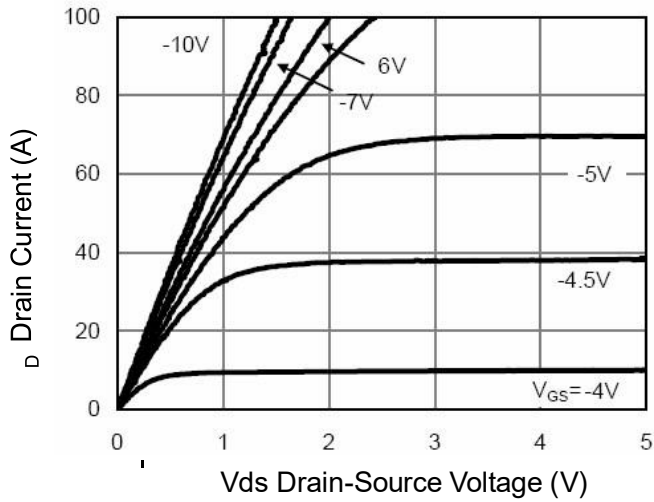

Figure 1 Output Characteristics

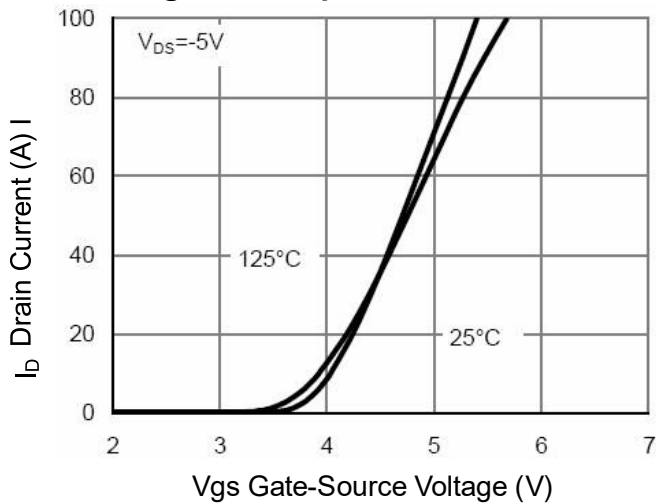

Figure 2 Transfer Characteristics

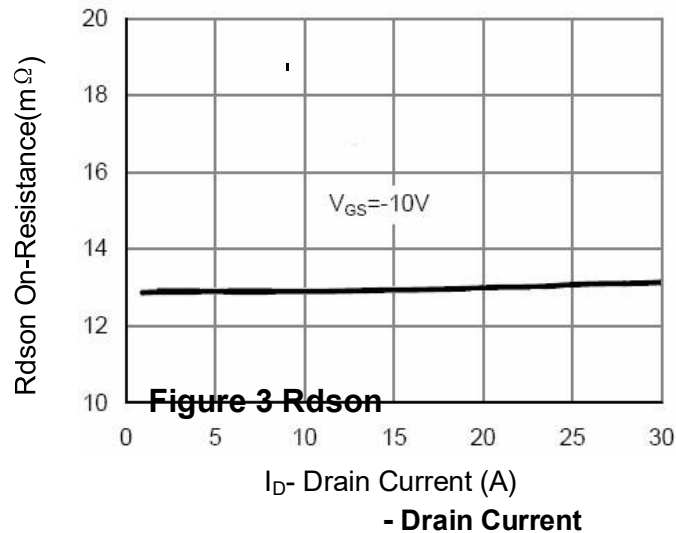

Figure 3 Rdson

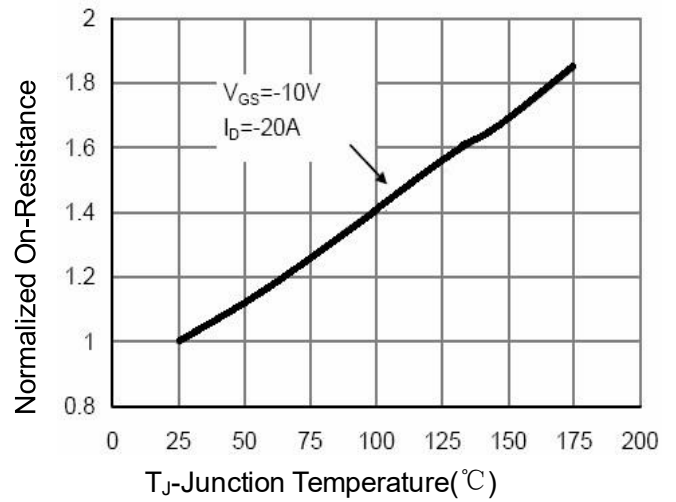

Figure 4 $R_{DS(on)}$ -Junction Temperature

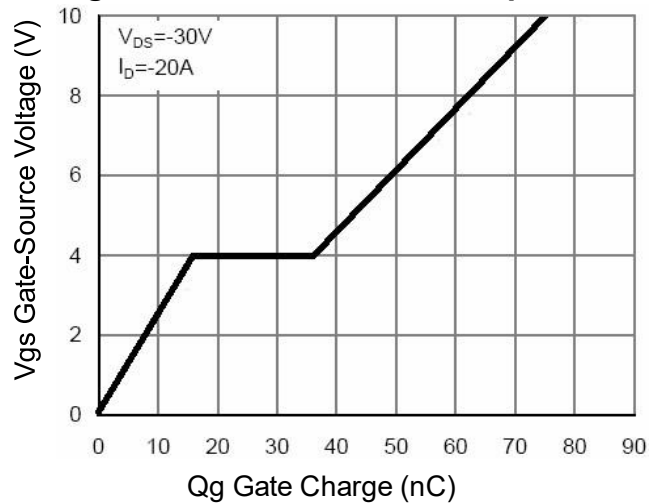

Figure 5 Gate Charge

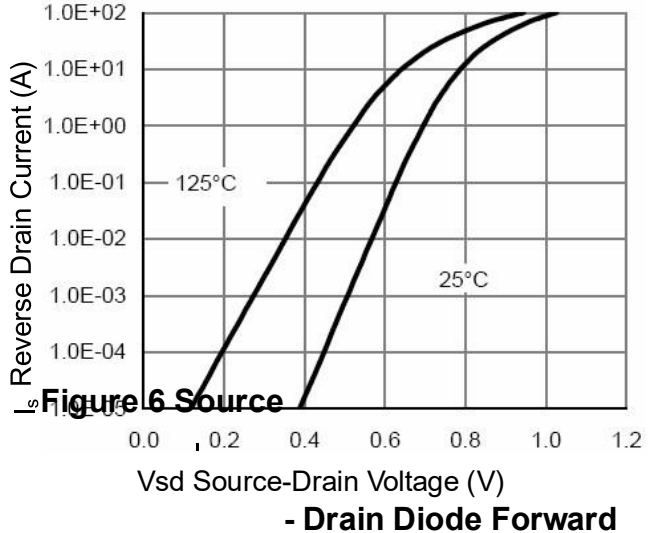

Figure 6 Source

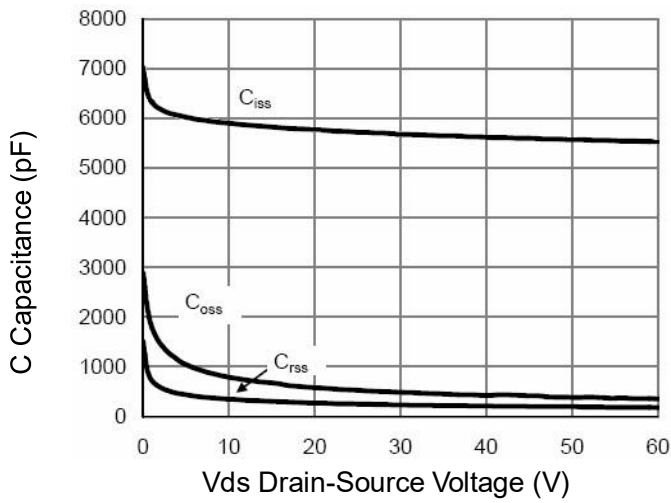

Figure 7 Capacitance vs Vds

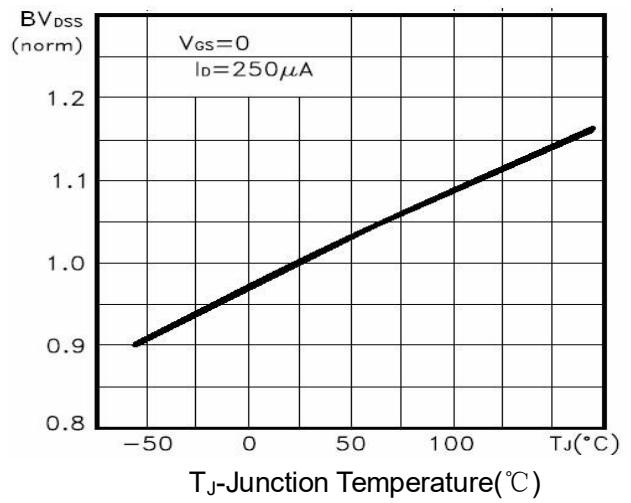

Figure 9 BV_{DSS} vs Junction Temperature

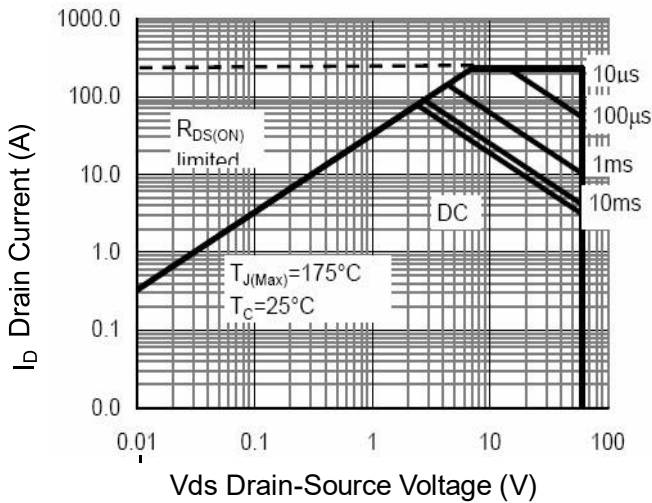

Figure 8 Safe Operation Area

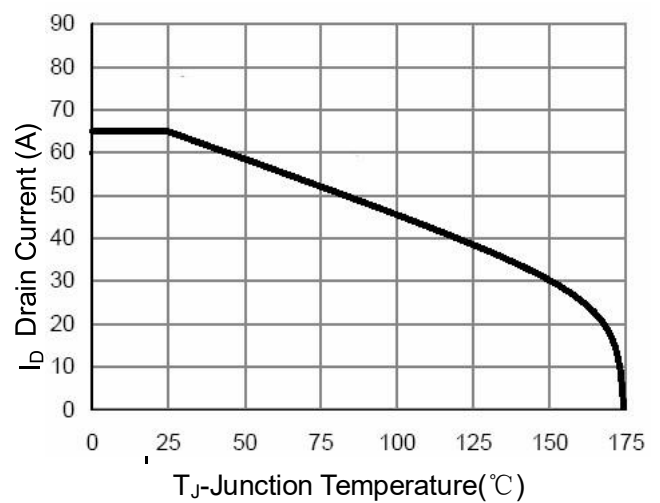
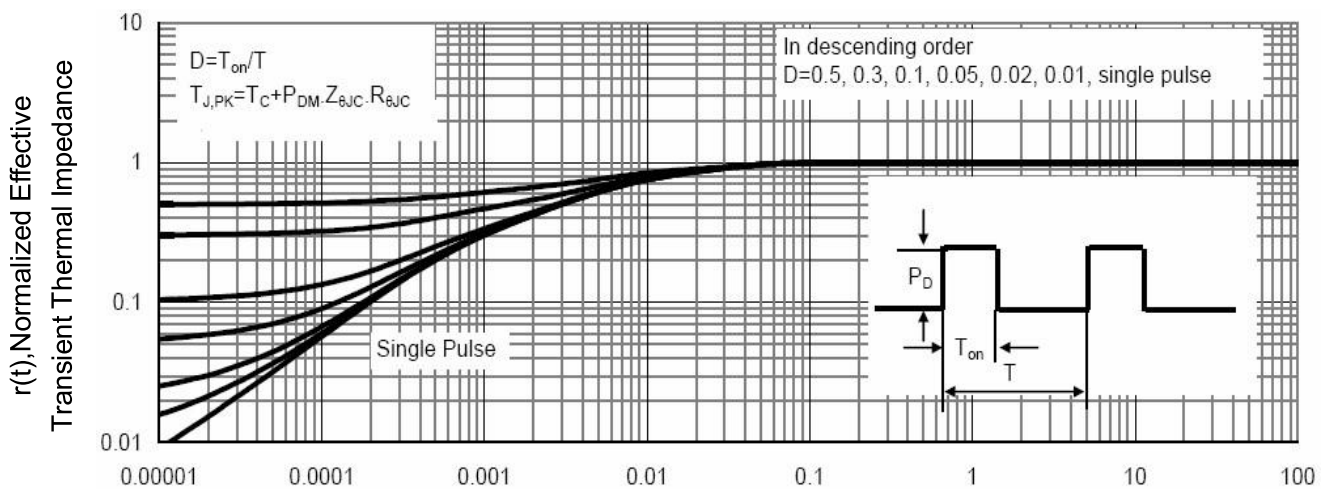
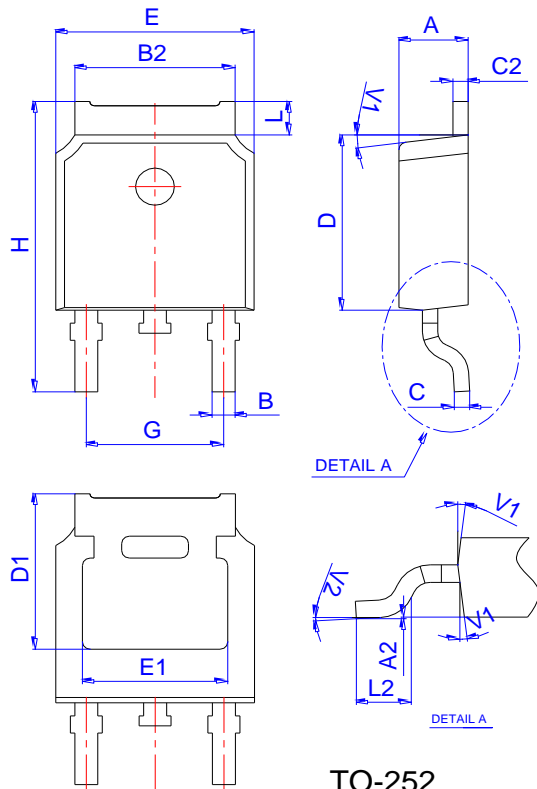

Figure 10 I_D Current Derating vs Junction Temperature



Package Mechanical Data



Ref.	Dimensions					
	Millimeters			Inches		
	Min.	Typ.	Max.	Min.	Typ.	Max.
A	2.10		2.50	0.083		0.098
A2	0		0.10	0		0.004
B	0.66		0.86	0.026		0.034
B2	5.18		5.48	0.202		0.216
C	0.40		0.60	0.016		0.024
C2	0.44		0.58	0.017		0.023
D	5.90		6.30	0.232		0.248
D1	5.30REF			0.209REF		
E	6.40		6.80	0.252		0.268
E1	4.63			0.182		
G	4.47		4.67	0.176		0.184
H	9.50		10.70	0.374		0.421
L	1.09		1.21	0.043		0.048
L2	1.35		1.65	0.053		0.065
V1		7°			7°	
V2	0°		6°	0°		6°

Reel Specification-TO-252

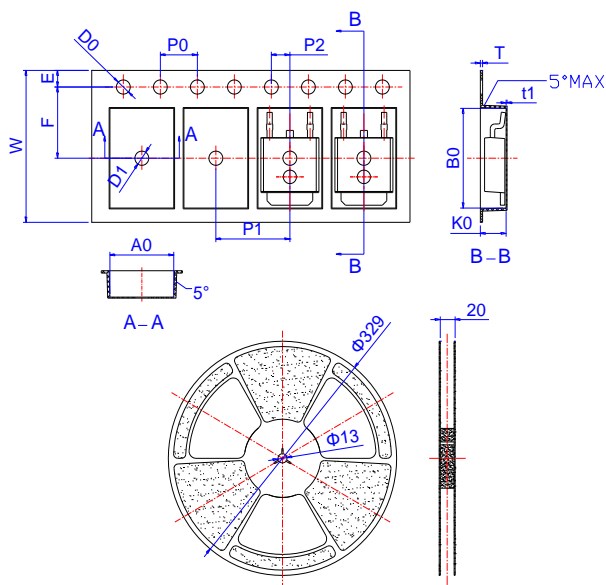

Ref.	Dimensions					
	Millimeters			Inches		
	Min.	Typ.	Max.	Min.	Typ.	Max.
W	15.90	16.00	16.10	0.626	0.630	0.634
E	1.65	1.75	1.85	0.065	0.069	0.073
F	7.40	7.50	7.60	0.291	0.295	0.299
D0	1.40	1.50	1.60	0.055	0.059	0.063
D1	1.40	1.50	1.60	0.055	0.059	0.063
P0	3.90	4.00	4.10	0.154	0.157	0.161
P1	7.90	8.00	8.10	0.311	0.315	0.319
P2	1.90	2.00	2.10	0.075	0.079	0.083
A0	6.85	6.90	7.00	0.270	0.271	0.276
B0	10.45	10.50	10.60	0.411	0.413	0.417
K0	2.68	2.78	2.88	0.105	0.109	0.113
T	0.24		0.27	0.009		0.011
t1	0.10			0.004		
10P0	39.80	40.00	40.20	1.567	1.575	1.583